

Pos. Nr. Pos.no.	Beschreibung Description	Art.-Nr. Art.no.	Preisgruppe Price bracket
72011	SNCF Y 8400		
78011			
1	Motorvorbau 8504 Motor housing 8504	146356	30
2	TS - Fenster+Lichtnägel Part set - Windows+light pins	144764	11
3	Lichtnagel Light pin	144765	4
4	Rangiergriff Shunter hand-rail	144766	3
5	Umlaufrahmen Running way frame	146352	18
6	TS - Treppe+Bremseleitung Part set - steps+brake lines	146353	7
7	Tank Tank	146354	10
8	TS - Kasten, Behälter Part set - Boxes, container	144770	10
9	TS - Umlauf Part set - Running way	144771	7
10	TS - Scheibenwischer + Bremsschlauch Part set - Wipers+Brake tubes	144773	9
11	TS - Geländer Part set - Railing	144775	9
12	Platine Onboarddecoder PCB	144776	42
13	Motor KM Motor	145018	25
14	Flexplatine Flexible PCB	144762	11
15	Lautsprecher Loudspeaker	129524	13
16	TS - Gehäuse Part set - Body	145021	6
17	Führerhaus Drivers cab	146357	30
18	Spule Spool	144778	13
19	GF-Schraube M1 6x5 mm GF-Screw	115269	3
20	Anzeigentafel Panel	146358	6

Änderungen in Konstruktion und Ausführung vorbehalten
We reserve the right to change the construction and specification

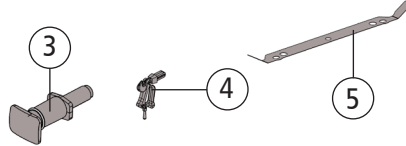

72011	SNCF	Y 8400	=	🔊	
78011			=	🔊	~

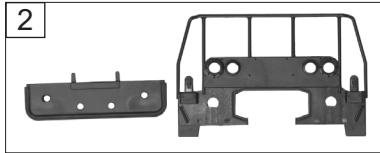
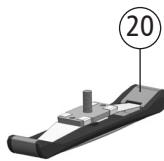
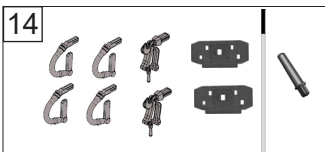
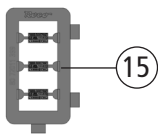
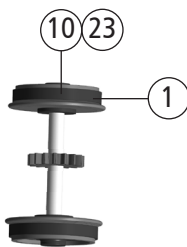
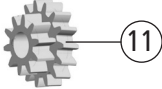
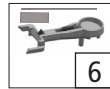
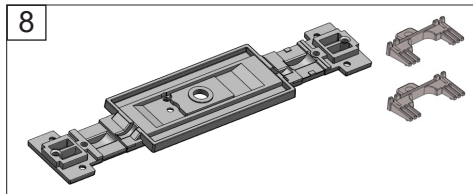
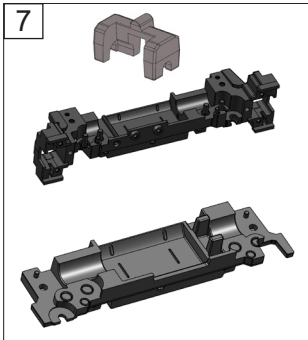

Pos. Nr. Pos.no.	Beschreibung Description	Art.-Nr. Art.no.	Preisgruppe Price bracket
1	Hafrings 10 stk. 10,3-12,8 Traction tyre	40069	---
2	TS - Pufferplatte Part set Buffer plate	146364	4
3	Puffer eckig Buffer rectangular	144772	3
4	Zughaken kurz Coupling hook short	144774	3
5	Radkontakt Wheel contact	144777	9
6	TS - Digital Kupplung Part set - Digital coupling	143765	10
7	Getriebesatz 3tlg. Gear set	144779	9
8	Boden + Flexhalter Bottom + flexible holder	145017	7
9	Radsatz m.Zahn. o.Haftr. Wheelset w. gearwh. w/o traction tyre	145019	11
10	Radsatz m.Zahn. m. 2 Haftr. Wheelset w. gearwh. w. 2 traction tyre	146355	12
11	Schnecken Zahnrad Z=10/15 M=0,4 Worm gear	86410	4
12	Zwischenzahnrad Z=12 M=0,4 Intermediate gear wheel	114163	3
13	Zahnrad Gear wheel	86510	4
14	Zurüstbeutel Bag of accessories	146359	9
15	Tafelsatz Set of panels	146360	12
16	GF - Schraube M1 6x4 mm GF - Screw	114850	3
17	SK - Schraube M2x5 mm SK - Screw	115205	3
18	SK - Schraube M1,6x3 mm SK - Screw	125023	3
19	GF - Schraube M1,6x12 mm GF - Screw	115138	3
AC - Wechselstrom			
20	Schleifer Slider	86030	14
21	GF - Schraube M1 6x3 mm GF - Screw	143760	4
22	Radsatz m.Zahn. o.Haftr. AC Wheelset w. gearwh. w/o traction tyre	145025	11
23	Radsatz m.Zahn. m. 2 Haftr. AC Wheelset w. gearwh. w. 2 traction tyre	146361	12